

# CM180v2 ESC MANUAL

## Disclaimer

Thank you for choosing this product. Please carefully read this manual before using this product. Using this product will indicate you're agreed with the all items in this manual. Please strictly follow these items during usage. We'll not commit any responsibility including but not limited to indirect loss or joint responsibility caused by improper usage, private modification and other faults.

## Attention

This part has strong power. High speed running propellers have certain safety risk. User must be older than 18 years and have relative professional knowledge. Before usage, please carefully check if all the components are in good conditions.

## Features

Support dual throttle (CAN digital throttle +PWM analog throttle) control, priority CAN digital throttle control. Quick response. it will take only 0.28 seconds from starting motor to full speed running. Good compatibility and stability with special control algorithm for disc motors. Synchronous flow technology, with better throttle linearity and drive efficiency. Further, during deceleration, the ESC will automatically recycle energy and charge the battery reversely for extending flight time. Has RPM, error signal output interface. With CAN communication interface, can be real-time communication with the flight control. (Note: This function needs to be matched with flight control). Both control signal interface and main power are fully isolated, safer and more reliable.

## Protection Function

### Short Circuit Protection

When ESC detects a short circuit, it will trigger short circuit protection and automatically turn off the output. After 100ms, ESC automatically restarts and resumes operation.

### Stalling Protection

Motor stall will trigger stalling protection. ESC will resume after making throttle zero and powering again.

### Voltage Protection

Once checking voltage is less than 16V or more than 80V, ESC will alarm and will not start up motor. But it will be out of effect during flying.

### Temperature Protection

During flight, if the temperature of the ESC is higher than 125°C, it will generate a fault signal and start reducing the output power to 50% of the maximum value. If the temperature continues to rise to 140°C, the ESC will turn off the output, and the normal output will not be restored until the throttle setting is reset to zero. When the temperature drops to 80°C, the output power of the ESC starts to rise to the maximum value.

### Throttle Loss Protection

When the detected throttle signal is lost for more than 2 seconds, the ESC will automatically shut down. After the throttle signal is restored, the ESC will work again.

### Start Protection

If the throttle is accelerated for 10 seconds but the motor fails to start, the ESC will turn off the output. In this case, you need to reset the throttle to zero, and then accelerate the throttle to return to normal.

### Throttle Stroke Setting

First to connect motor with ESC, then to power on & adjust throttle to top, you will hear sound of Beep-Beep for two times. Then adjust the throttle to lowest, you will hear a sound of Do-Mi-So, that means the throttle stroke has been set successfully.

## ESC Connection

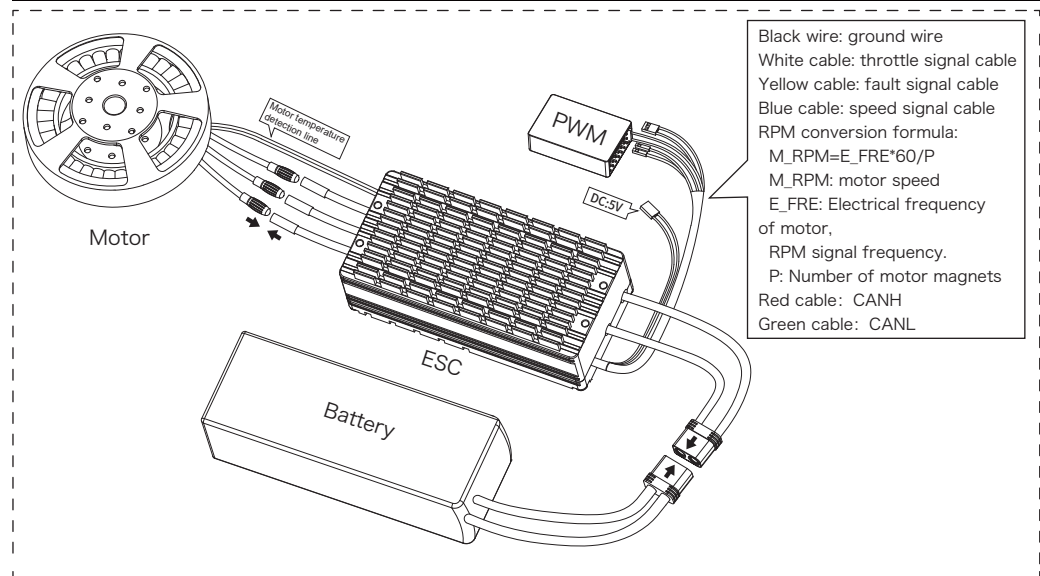

## ESC Parameter

Model: CM180 v2  
 BEC: 5V/200MA output  
 PWM Input Signal Voltage: 3.3V/5V(compatible)  
 Online Update: available  
 Throttle Loss Protection: available  
 Phase Short Circuit Protection: available  
 Size(L\*W\*H): 117.5\*56.3\*42.8mm  
 Power Line: 8AWG  
 Continuous Current: 180A (under good cooling conditions)  
 Current limiting: 180A  
 Voltage Protection: available  
 Temperature Protection: available  
 Speed Signal Output: available  
 Weight(without lines): 286g  
 Working Environmental Temperature: -20~65 °C  
 Throttle Pulse Width: default 1050us-1940us, throttle adjustment is available.

Battery Section: 5~18S  
 Recommended Battery: 18S  
 Compatible Signal Frequency: 50-500Hz  
 Stall Protection: available  
 Error Signal Output: available  
 Protection Grade: IPX4  
 Motor Line: 8AWG  
 Communication interface: CAN

## Trouble Shooting

Problem	Alarm	Cause	Solution
Motor can't start after powering on.	Quick noise of beep beep beep...	Throttle is not made zero.	Adjust throttle to bottom
Motor can't start after powering on.	Beep, beep, beep... every 1 second.	Receiver has not throttle output signal.	Check sender and receiver co-work condition, check throttle control lines.
Voltage is less than 16V.	Beep-Beep, Beep-Beep... every 1 second.	Battery voltage is too low.	Change full power battery.
Voltage is more than 80V.	Beep-Beep, Beep-Beep... every 1 second.	Battery voltage is too high	Change proper full power battery.
Temperature is higher than 125°C	Beep-Beep-Beep, Beep-Beep-Beep... every 1 second.	ESC's temperature is too high	Please cool down the ESC in a ventilated place
The power-on current or short-circuit protection is abnormal	Beep-Beep-Beep-Beep, Beep-Beep-Beep-Beep... every 1 second.	Overload	Replace the appropriate propeller blades